

IMPORTANT

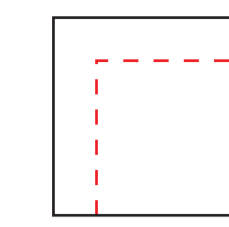

CRITICAL AREA

Keep all important elements of the artwork inside the dotted line!
The "CRITICAL AREA" ensures that all the important elements in your artwork will be printed clearly when the product is produced.

— DIE LINE
THE FABRIC WILL BE CUT HERE

- - - STITCH LINE
THE PANELS WILL BE STITCHED TOGETHER HERE

— BLEED EDGE
ARTWORK TO BE LAID OUT TO THIS EDGE

ARTWORKS MUST FILL ALL OF THE GRAY AREAS. EXAMPLE:

INCORRECT



CORRECT

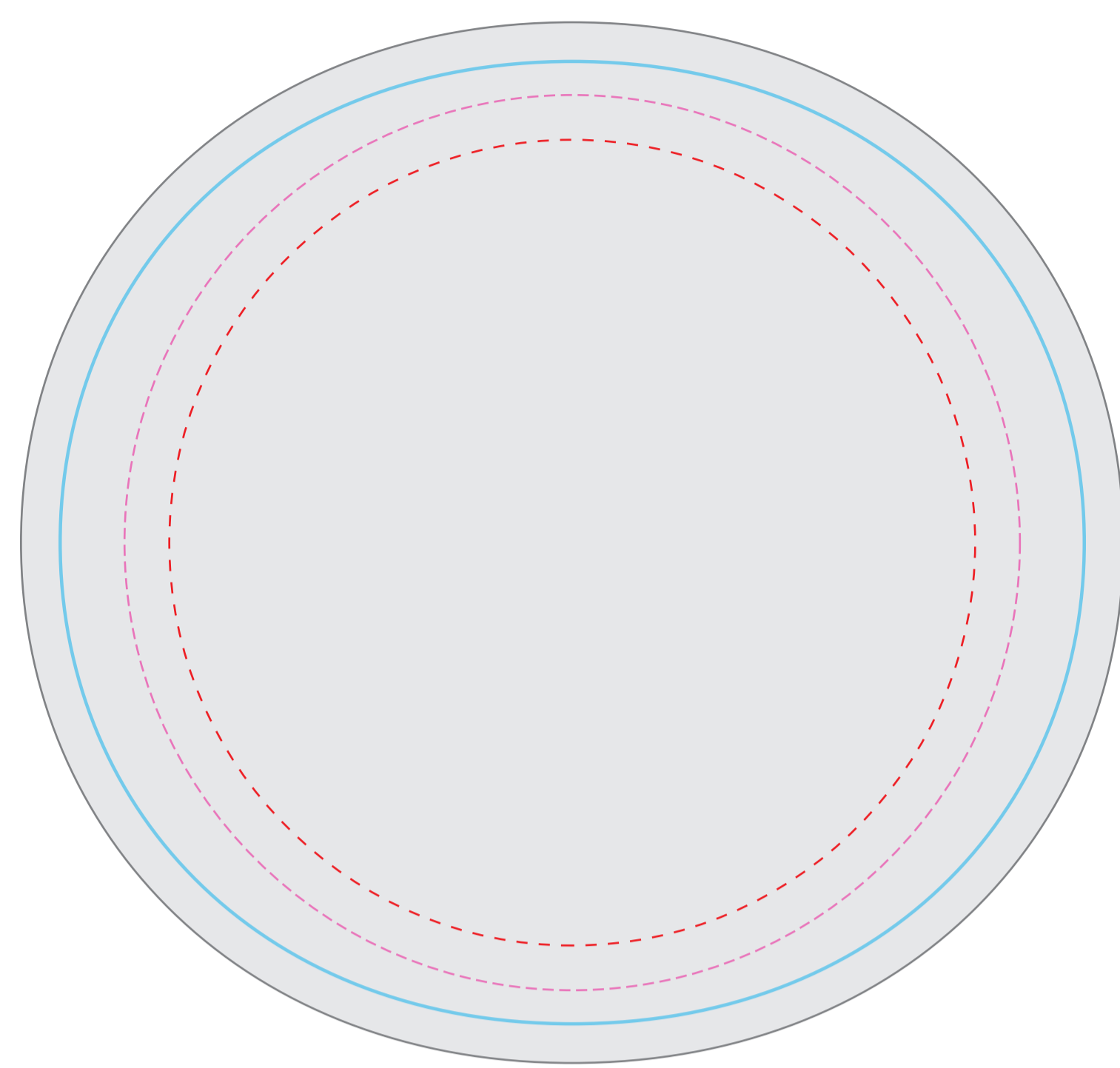

TOP

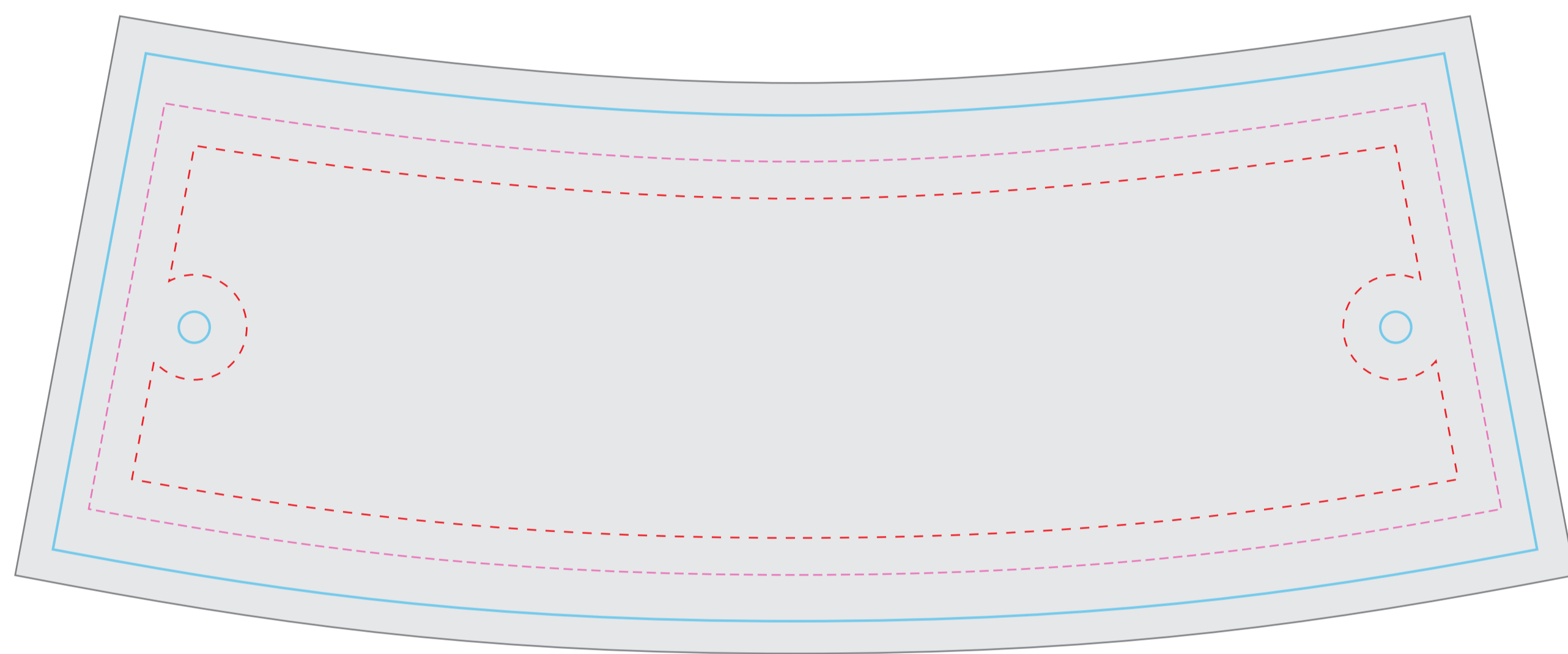

SIDE 1

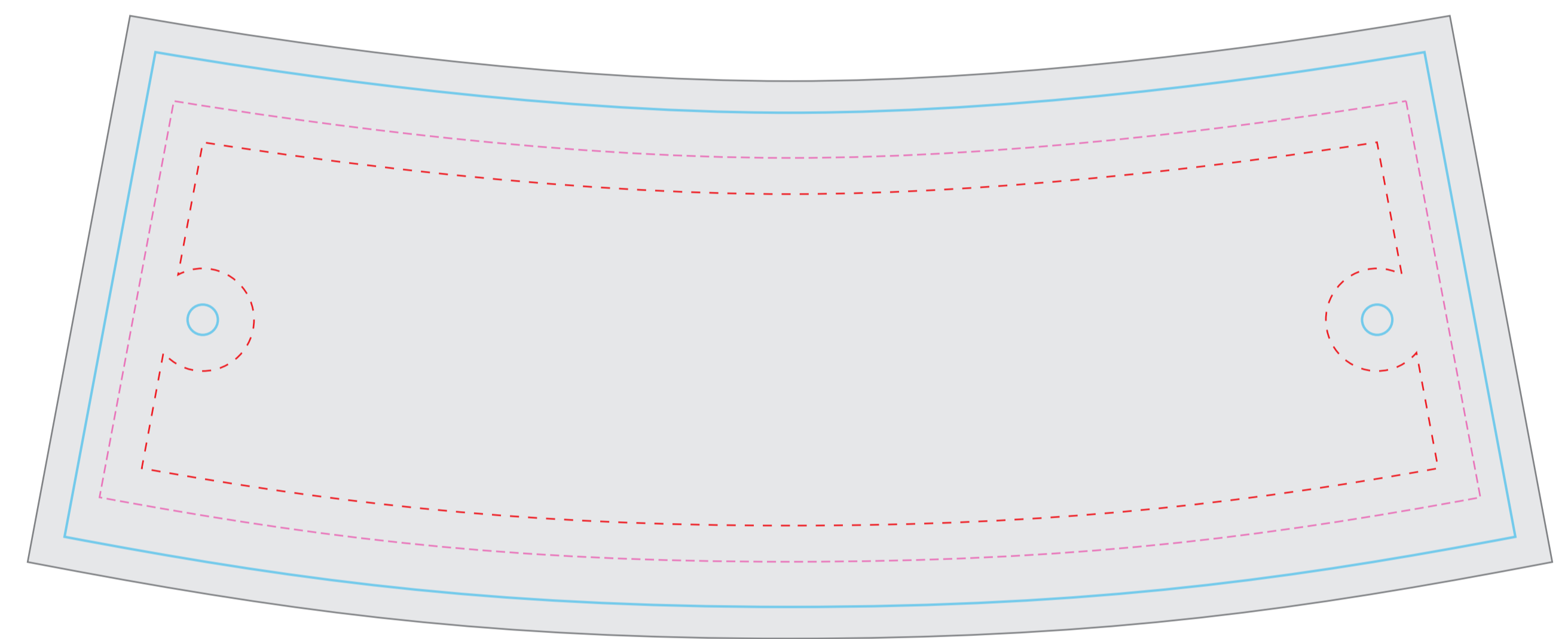

SIDE 2

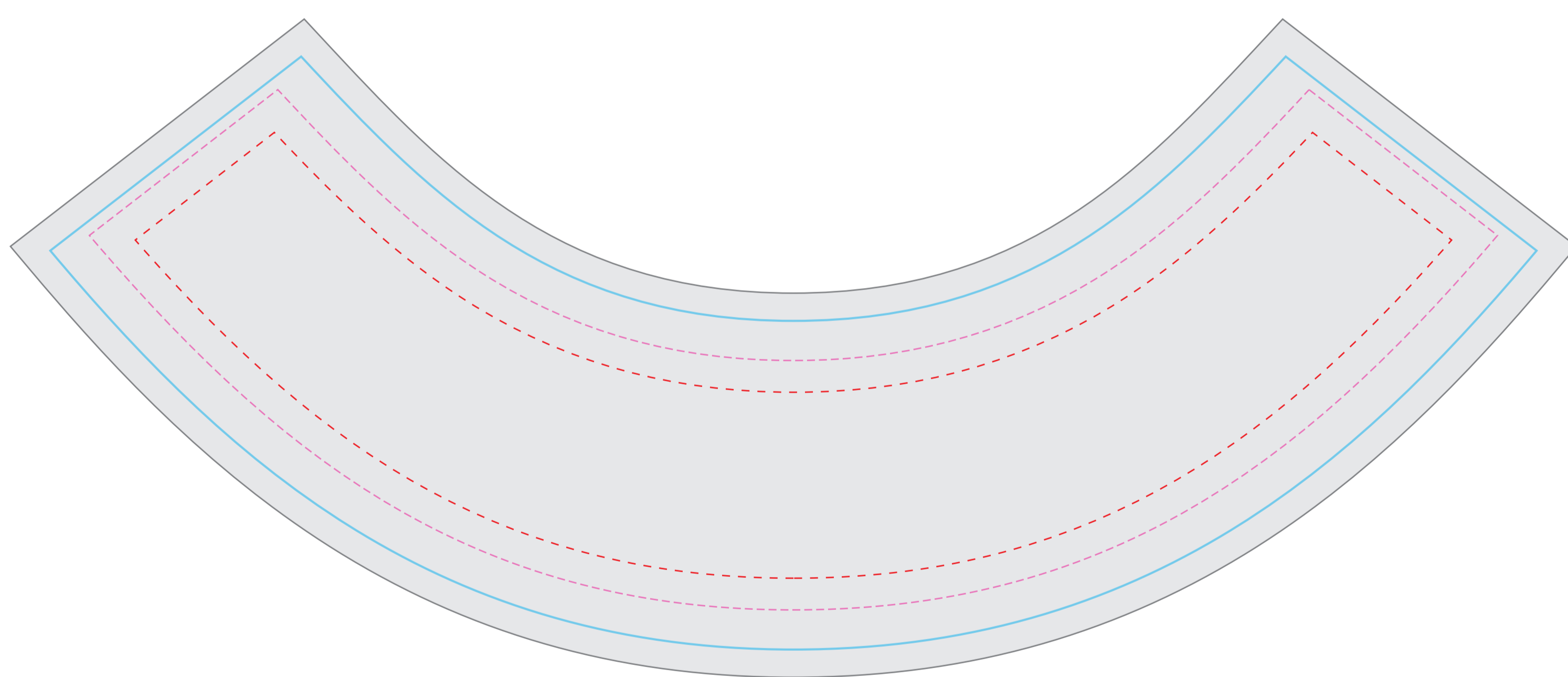

SIDE 1 - RIM

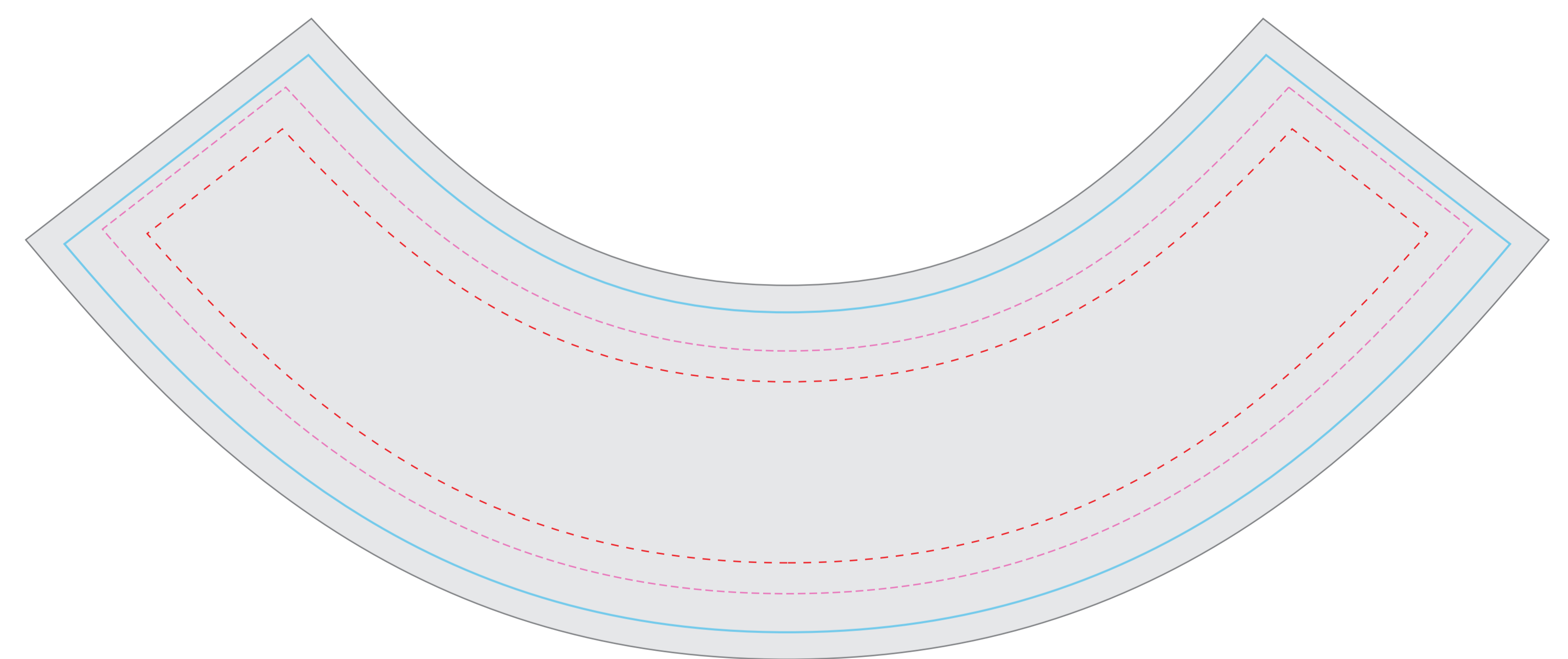

SIDE 2 - RIM

TEMPLATE SCALE RATIO 1:1

ART COLOURS

FULL COLOUR

COLOUR MATCH >>> ■ PMS ■ PMS
■ PMS ■ PMS
■ PMS ■ PMS

PRODUCT COLOURS

FABRIC: WHITE
EYELETS: —
UNDER RIM: - - -
TAPE: —
SWEATBAND: —

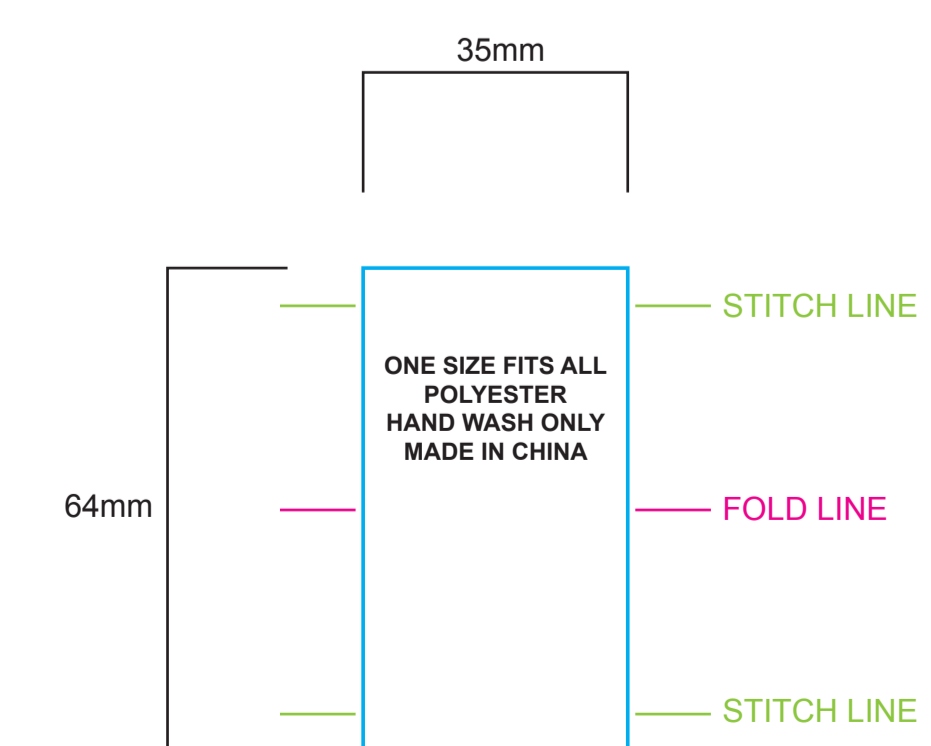

CARE LABEL